

21181
 OG 128

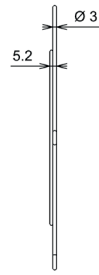

21194
 OJ 150

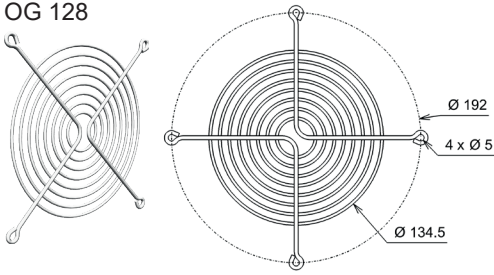
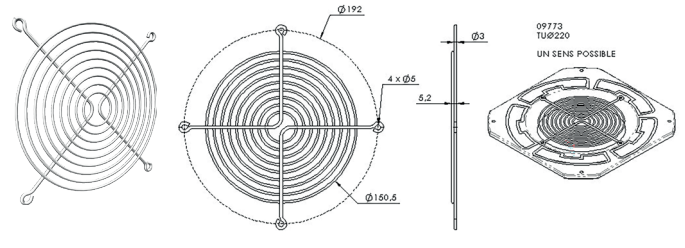

21197
 OH 118

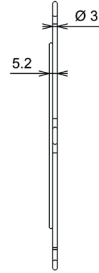
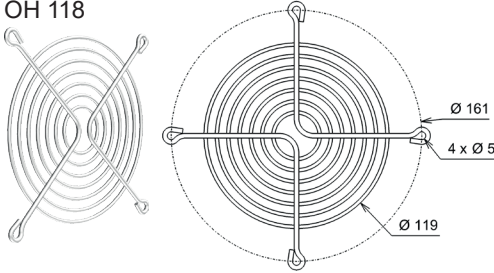

21367
 VS Df 118

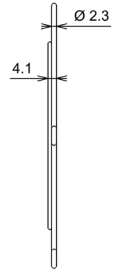
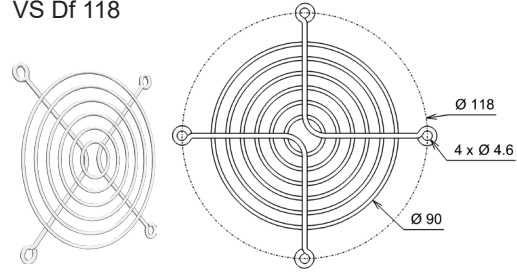

21359

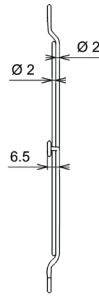
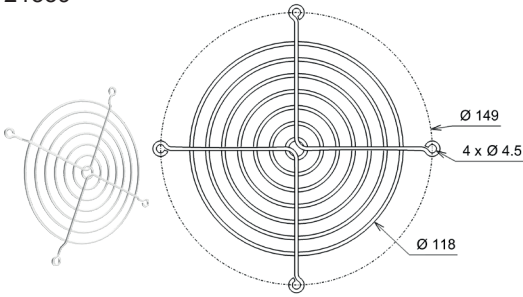

21196
 VL Df 216

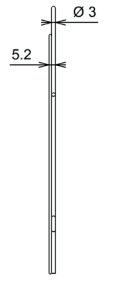
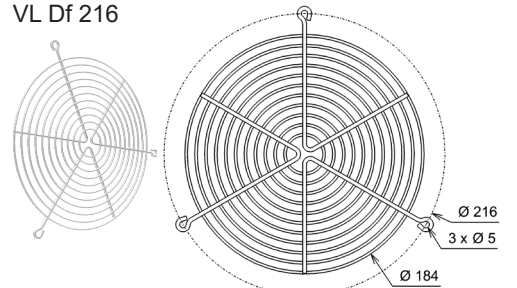

21236
 VR Df 144

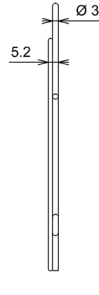
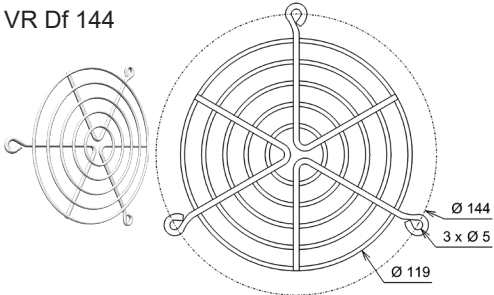

21237
 VS Df 134

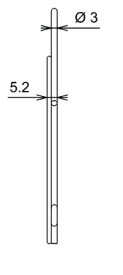
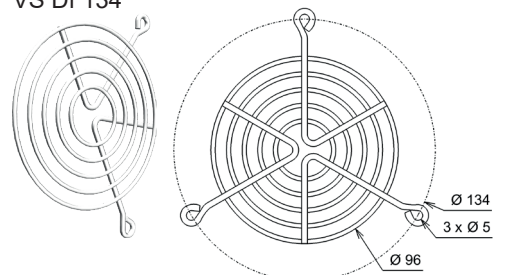

21290
 VH Df 161 H 15

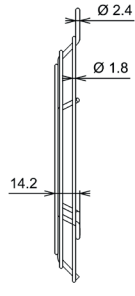
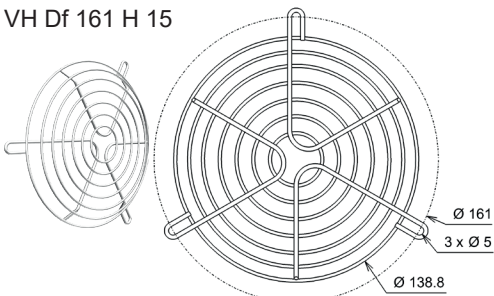

21291
 VV Df 192 H 18

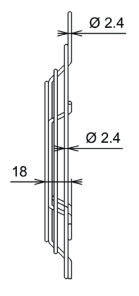
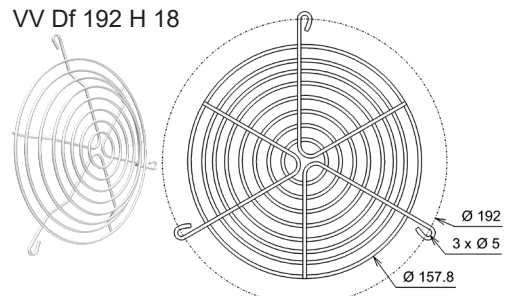

21325
 VV Df 192

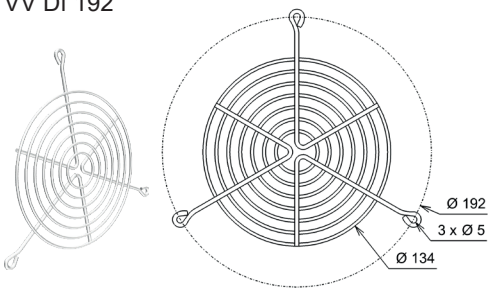

21338
 VR Df 161

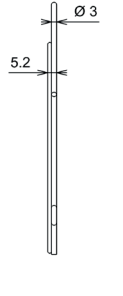
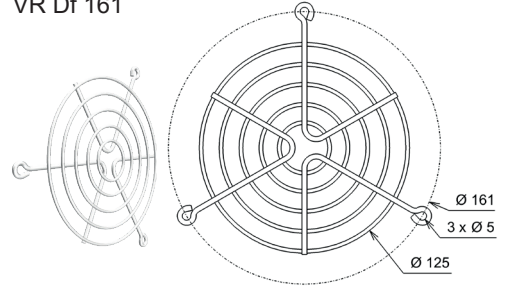

21188

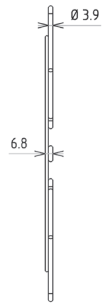
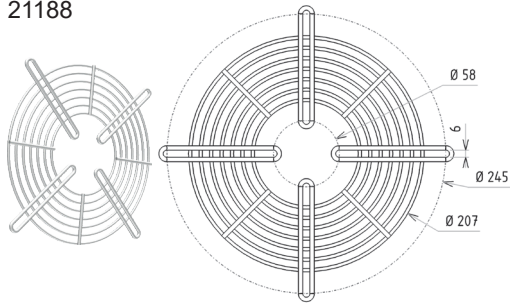

21189

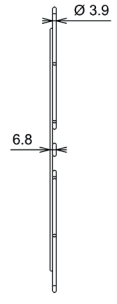
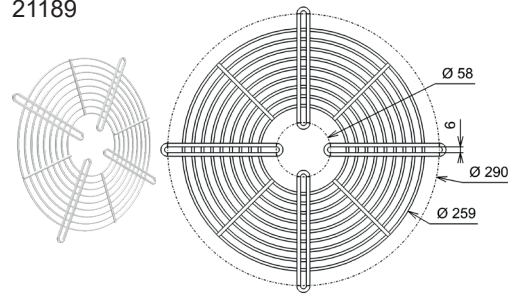

21190

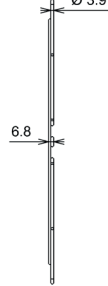
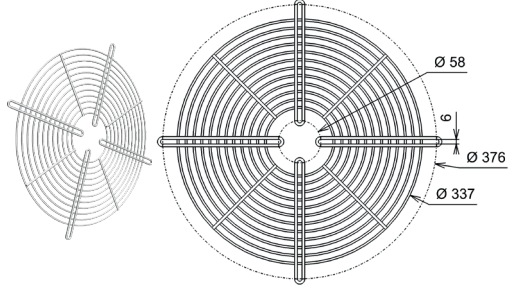

21191

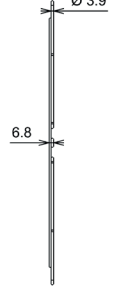
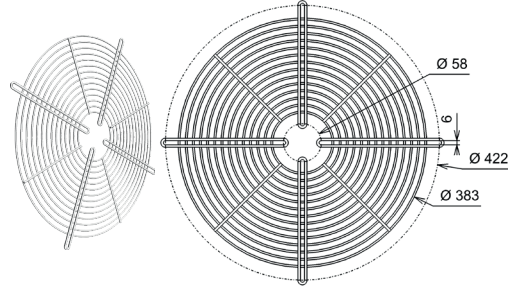

21192

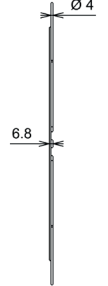
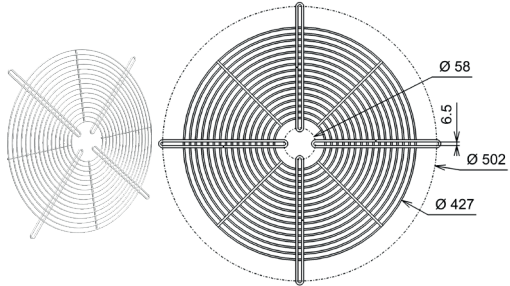

21360
RRE INV Ø250
& Ø280
VGC 200 (Alu)

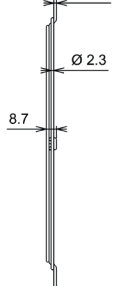
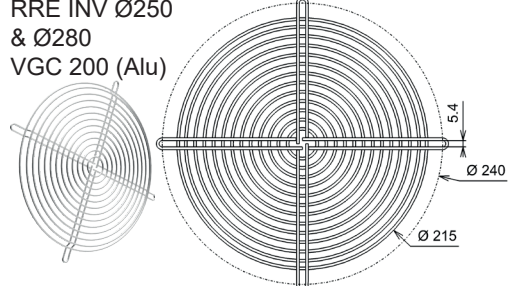

21369
VGC 250
(Alu)

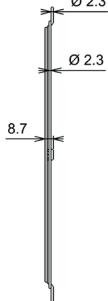
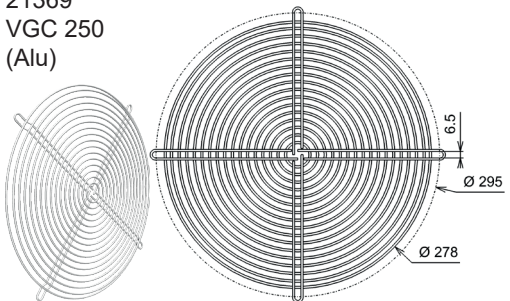

21419

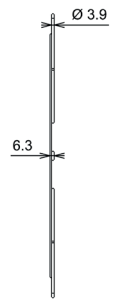
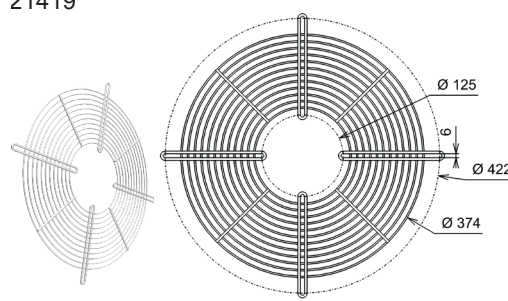

21420

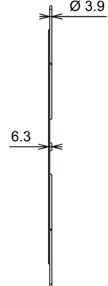
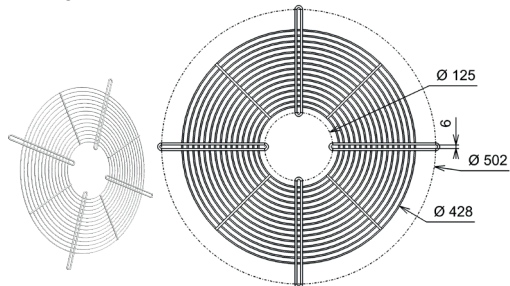

21366
RRE INV Ø180
& Ø192

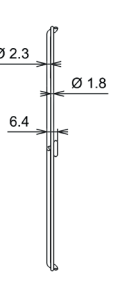
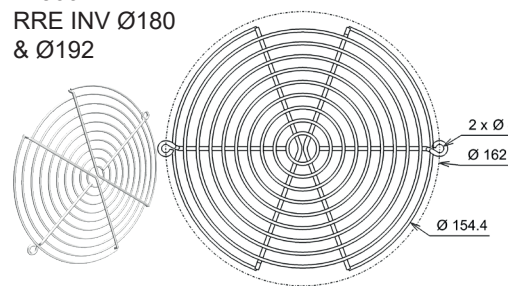

21506

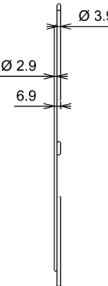
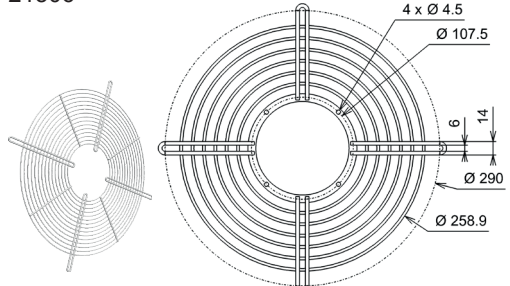

21522

